

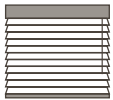









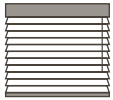

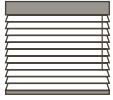

TOPPOINT

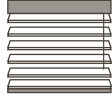
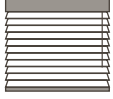
SCALA[®] ALUMINIUM JALOEZIEËN

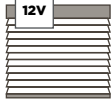
www.toppoint.eu

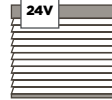
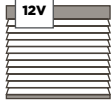
MAATVOERINGEN

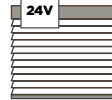
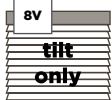
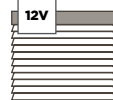
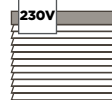
		Bediening					
		hoogte toleranties	koord	mono ketting	Openview®	EasyClick®	
		(cm)	> 200 cm breed = 2 koordremmen < 60 cm breed = gesplitste bediening	50 mm jaloezie: < 80 cm breed = enkel bediening rechts kettingoverbrenging: 25 mm jaloezie = 1:5 50 mm jaloezie = 1:4		< 50 cm breed = 1 handgreep > 50 cm breed = 2 handgrepen	
16 mm	+1.0 / -1.0		min 30 x 30 max 270 x 325 6,5 m ²		min 50 x 30 max 325 x 320 5,0 m ²		
	+1.0 / -1.0		min 30 x 30 max 325 x 325 8,0 m ²		min 50 x 30 max 325 x 320 5,0 m ²		
35 mm	+1.0 / -1.0		min 30 x 30 max 325 x 325 8,0 m ²				
50 mm	+1.5 / -1.0		min 41 x 30 max 400 x 325 12,0 m ²		min 56 x 30 max 350 x 300 8,5 m ²		
70 mm	+1.5 / -1.0		min 41 x 30 max 400 x 325 12,0 m ²				

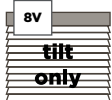
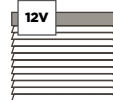
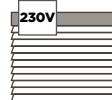
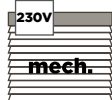
		Bediening			
		elektrisch			
16 mm					
	min 63 x 30 max 270 x 325 5,0 m ²	min 53 x 30 max 270 x 325 5,0 m ²	min 73 x 30 max 270 x 325 5,0 m ²		
					
25 mm	min 63 x 30 max 300 x 325 5,0 m ²	min 53 x 30 max 300 x 325 5,0 m ²	min 73 x 30 max 300 x 325 5,0 m ²		
35 mm					
50 mm					
	min 73 x 30 max 400 x 325 12,0 m ²	min 82 x 30 max 690 x 325 21,0 m ²	min 73 x 30 max 690 x 325 21,0 m ²	min 65 x 30 max 690 x 325 21,0 m ²	
70 mm					
	min 73 x 30 max 400 x 325 12,0 m ²	min 82 x 30 max 690 x 325 21,0 m ²	min 73 x 30 max 690 x 325 21,0 m ²	min 65 x 30 max 690 x 325 21,0 m ²	

		lamelbreedte	16 mm	25 mm	35 mm	50 mm	70 mm
		product- hoogte (cm)	pakkethoogte (cm)				
ladderkoord	0 - 100		9	7	6	12	10
	100 - 150	11	8.5	7.5	13	11	
	150 - 200	13	10	9	14	12	
	200 - 250	15	11.5	10	15	13	
	250 - 300	17	13	11	16	14	
ladderband	0 - 100	-	-	-	14	-	
	100 - 150	-	-	-	16	-	
	150 - 200	-	-	-	17	-	
	200 - 250	-	-	-	19	-	
	250 - 300	-	-	-	21	-	

Ladderkoorden / -banden			
	breedte (cm)	aantal	
16 mm	ladderkoord	36 - 64,5	2
		64,6 - 104,5	3
		104,6 - 125	4
		125,1 - 144,5	4
		144,6 - 184,5	5
		184,6 - 224,5	6
		224,6 - 264,5	7
		264,6 - 325,0	8
25, 35 mm	ladderkoord	36 - 75	2
		75,1 - 135	3
		135,1 - 180	4
		180,1 - 220	5
		220,1 - 300	6
		300,1 - 325	7
	50, 70 mm + XL	ladderkoord / -band	41 - 120
		120,1 - 200	3
		200,1 - 280	4
		280,1 - 360	5
		360,1 - 400	6
		400,1 - 430	6
		430,1 - 650	7
		650,1 - 690	8

AFWERKINGSMOGELIJKHEDEN

FIXEERBEUGEL

Kleur: transparant
Lamelbreedte: 16 & 25 mm
Toepassing: bijv. een deur (geen hellingshoek)

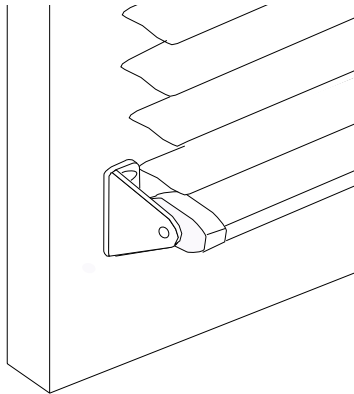

KLEMSTEUN TBV DRAAIKIEPRAAM

Kleur: wit
Lamelbreedte: 16 & 25 mm
Toepassing: i.c.m. zijgeleiding

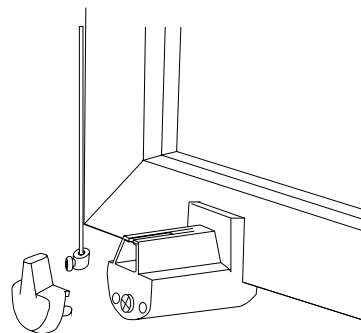
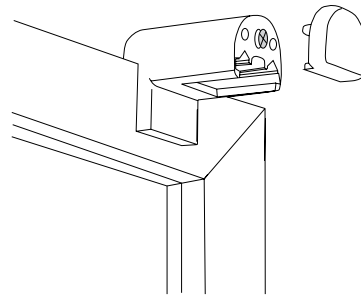

ZIJGELEIDING DMV SPANDRADEN

Kleur: staaldraad
 50 & 70 mm spanschoenset = aluminium
 16, 25 & 35 mm spanschoenset = transparant

Lamelbreedte: 16, 25, 35, 50 & 70 mm (koord)
 16, 25, 50 & 70 mm (elektrisch)

Toepassing: koord- en elektrische bediening
 schuin tot max. 25°

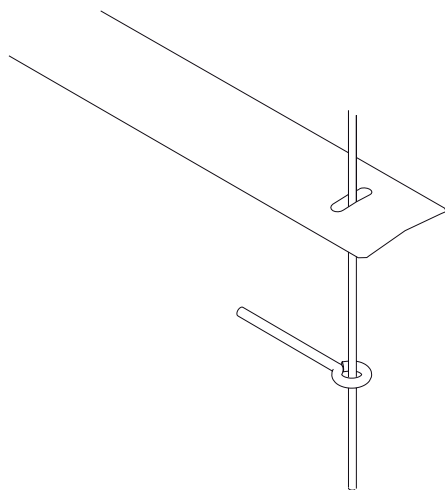

		Spanschoenset	
		Montage "in de dag"	Montage "op de dag"
16, 25, 35 mm			
50 & 70 mm			

AFWERKINGEN KLEUR

jalozeikleur

bovenprofiel + onderprofiel

71065
71066
71067
71068
71071
71076
71078
71079
71082
71086
71087
71083 - 73384 - 71101 - 71160 - 71122 - 71167
71102
73371 - 71074 - 71119 - 71085
71128 - 71153 - 73304 - 71127 - 71064
71131 - 71084
71100 - 71138 - 71148 - 72032 - 73361 - 73348 - 73352
71143
71164
71174 - 71072
71181 - 71152 - 71124
71110 - 71184
71188 - 71075
71193
78104 - 71290 - 79224
73301 - 71062 - 71063
73302 - 71165 - 71135
73303 - 71196 - 73382 - 73327
73305 - 73306 - 78000 - 71125
73307 - 73311 - 71081
73308 - 71162 - 71190
73309 - 71211
71170 - 73310
73312
73314
73315 - 71173
73324 - 73317 - 71163
73319 - 71077
73359 - 73323 - 71140
71129 - 73326 - 71161 - 77344 - 78004 - 71195 - 71080
73346
72789 - 71121 - 71182 - 73370 - 71199 - 73329
78101 - 73325 - 71088

71065
71066
71067
71068
71071
71076
71078
71079
71082
71086
71087
71101
71102
71119
71128
71131
71138
71143
71164
71174
71181
71184
71188
71193
71290
73301
73302
73303
73305
73307
73308
73309
73310
73312
73314
73315
73317
73319
73323
73326
73346
73370
78101

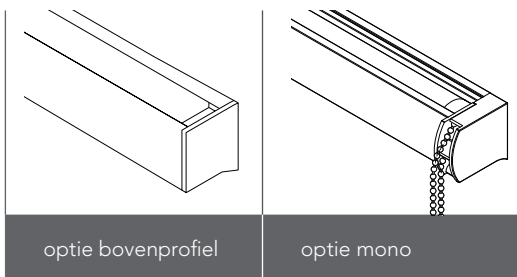





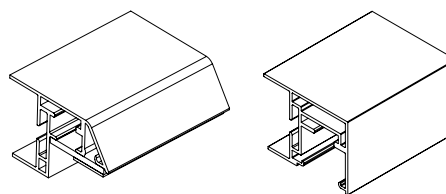













optie bovenprofiel

optie mono





EasyClick® & EasyEdge®

	ketting	commando
 RAL 7016 fijnstructuur	 antraciet PVC	 RAL 7016
 RAL 9005 fijnstructuur	 zwart PVC	 RAL 9005
 geanodiseerd champagne	 antraciet PVC	 RAL 7030
 geanodiseerd	 grijs PVC	 RAL 7047
 RAL 9010 fijnstructuur	 wit PVC	 RAL 9010
 RAL 9016 fijnstructuur	 wit PVC	 RAL 9016

frame
 RAL 7016 mat fijnstructuur
 RAL 9005 mat fijnstructuur
 RAL 9010 mat fijnstructuur
 RAL 9001 mat fijnstructuur
 RAL 9016 mat fijnstructuur
<p>Optioneel leverbaar in elke RAL kleur.</p> <p>Tuimelstang, handgrepen, boven- en onderprofielen zijn bijpassend aan de kleur van het EasyClick® & EasyEdge® frame.</p> <p>Bij standaard frame kleuren is de kleur van het bovenprofiel gelijk aan de kleur van het EasyClick® en EasyEdge® frame. Bij afwijkende Ral kleuren is de kleur van het bovenprofiel gelijk aan de kleur van de lamellen. Het onderprofiel heeft altijd de kleur van het EasyClick® en EasyEdge® frame.</p> <p>Vanaf 50 cm breed heeft de EasyClick® & EasyEdge® 2 handgrepen per profiel.</p> <p>Bij EasyEdge® IDD is de optie om een alu afdekstrip te bestellen in bijpassende kleur en afwerking van het frame.</p>

ELEKTRA MOTOREN BREL



Type	Brel 8 volt Tilt only	Brel 12 volt	Brel 12 volt + int. accu	Brel 230 volt	Brel 230 volt mech.
Scala® 16/25 mm		✓			
Scala® 50/70 mm	✓		✓	✓	✓
Scala® XL7			✓	✓	✓
Voeding (verplicht te kiezen)	8 volt Tilt only	12 volt	12 volt + int. accu	230 volt	230 volt mech.
Brel T1 transformator (max. 1 product)		✓			
Brel T3 transformator (max. 3 producten)		✓			
Oplaadbare accu extern USB-C		✓			
Eigenschappen	8 volt Tilt only	12 volt	12 volt + int. accu	230 volt	230 volt mech.
Interne accu	✓		✓		
Externe accu		✓			
Bedrade stroomvoorziening 230 volt				✓	✓
Bedrade stroomvoorziening transformator		✓			
Type oplaadpunt	USB-C	USB-C	USB-C	n.v.t.	n.v.t.
Motor specificaties	8 volt Tilt only	12 volt	12 volt + int. accu	230 volt	230 volt mech.
Kabel lengte (mm)	n.v.t.	300	100	3000	3000
 Besturingen: 1-weg communicatie Geeft geen terugkoppeling	✓	✓	✓	✓	✓
 Besturingen: 2-weg communicatie Geeft terugkoppeling Bi-directioneel	✓	✓	✓	✓	
Domotica	8 volt Tilt only	12 volt	12 volt + int. accu	230 volt	230 volt mech.
Draadloze domotica (HUB)	✓	✓	✓	✓	
Bedrade domotica huisautomatisering					✓
Toebehoren	8 volt Tilt only	12 volt	12 volt + int. accu	230 volt	230 volt mech.
Brel T3 splitter (2-weg)		✓			
Brel T3 verlengkabel (25/50/100/200/500 cm)		✓			
Brel USB-C oplader (3 meter kabel)	✓	✓	✓		
Brel 15 kanaals afstandsbediening	✓	✓	✓	✓	
Brel 1 kanaals wandschakelaar	✓	✓	✓	✓	
Brel Hub DD-1554	✓	✓	✓	✓	
Brel Hub DD-7002B	✓	✓	✓	✓	

KOPPELEN MET BREL MOTOREN

Koppelen met hub

Alle motoren van Brel zijn met onder andere de volgende draadloze domotica systemen te gebruiken:

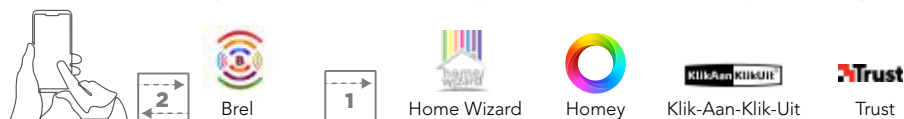

Koppelen met spraakbesturing



AFSTANDSBEDIENING

- Zie youtube: Toppoint raamdecoratie - afstellen bi-directionele motor Brel.
- Elektronisch geregelde afstelling.
- Geheugen voor de ingestelde posities en functies ook na stroomonderbreking.
- Detecteert het lopen van de motor en het aantal motor omwentelingen om zeker te zijn van een uitstekende afstelling.

LET OP!

Uw product is reeds volledig afgesteld /geprogrammeerd en klaar voor gebruik.
Zorg voor minimaal 20 cm ruimte tussen motoren met ingebouwde ontvanger.
Bij meerdere producten op 1 afstandsbediening is kanaal 0 standaard allen samen.

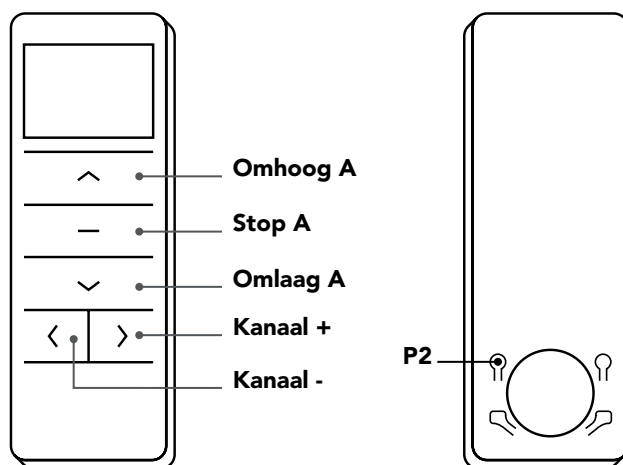

BEREIK

L1 = 100 meter

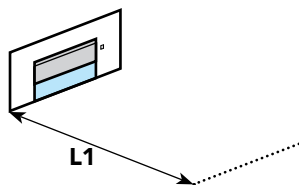

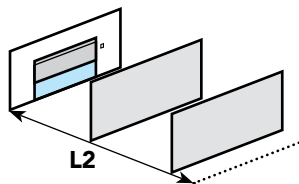

L2 = 25 meter



ELEKTRA MOTOREN SOMFY



Product raamdecoratie	Somfy 12 volt Tilt & Lift	Somfy 24 volt mech.	Somfy 230 volt RTS	Somfy 230 volt mech.	Somfy 230 volt IO
Scala® 16/25 mm	✓	✓			
Scala® 50/70 mm			✓	✓	✓
Scala® XL7			✓	✓	✓
Voeding (verplicht te kiezen)	12 volt Tilt & Lift	24 volt mech.	230 volt RTS	230 volt mech.	230 volt IO
Somfy 12 volt transformator	✓				
Somfy transformator 1.5		✓			
Somfy transformator 2.7		✓			
Opladbare accu extern USB-C	✓				
Eigenschappen	12 volt Tilt & Lift	24 volt mech.	230 volt RTS	230 volt mech.	230 volt IO
Interne accu					
Externe accu	✓				
Bedrade stroomvoorziening 230 volt			✓	✓	✓
Bedrade stroomvoorziening transformator	✓	✓			
Type oplaadpunt	JST	n.v.t.	n.v.t.	n.v.t.	n.v.t.
Motor specificaties	12 volt Tilt & Lift	24 volt mech.	230 volt RTS	230 volt mech.	230 volt IO
Kabel lengte (mm)	100	300	3000	2500	3000
 Besturingen: 1-weg communicatie Geeft geen terugkoppeling RTS	✓	✓	✓	✓	✓
 Besturingen: 2-weg communicatie Geeft terugkoppeling IO					✓
Domotica	12 volt Tilt & Lift	24 volt mech.	230 volt RTS	230 volt mech.	230 volt IO
Draadloze domotica (HUB)	✓		✓		✓
Bedrade domotica huisautomatisering		✓		✓	
Toebehoren	12 volt Tilt & Lift	24 volt mech.	230 volt RTS	230 volt mech.	230 volt IO
Somfy 12 volt oplader (3 meter kabel)	✓				
Somfy ontvanger RTS 25		✓			
Situo 1 RTS - 1 kanaals afstandsbediening	✓	✓	✓		
Situo 5 RTS - 5 kanaals afstandsbediening	✓	✓	✓		
Smoove Origin RTS - 1 kanaals wandchakelaar	✓	✓	✓		
Situo 1 IO - 1 kanaals afstandsbediening					✓
Situo 5 IO - 5 kanaals afstandsbediening					✓
Smoove Origin IO - 1 kanaals wandchakelaar					✓



METEN SCALA® JALOEZIEËN

VOORKOM TELEURSTELLINGEN

Voor u gaat meten: Is de plaats waar u het product wilt monteren vlak en waterpas? Is dit niet het geval, dan kan dit het goed functioneren en/of rechthangen van het product belemmeren. Kan de ondergrond het product dragen? Geef het product voldoende ruimte zodat het product niet in contact komt met klinken e.d.

De bediening wordt op min. 150 cm van de vloer gemaakt om zo de veiligheid van kinderen (ChildSafety) te waarborgen en te voldoen aan de EU-norm EN 16433 en EN 16434.

JALOEZIEËN NAAST ELKAAR

Bij jaloezieën naast elkaar zullen wij altijd proberen de lamellen door te laten lopen (max. 4 producten naast elkaar). Echter door de rek in de ladderbanden en -koorden is het niet 100% mogelijk. Zelfs bij identieke maatvoering kunnen wij dit niet garanderen.

Wij produceren uw product binnen de NEN-norm EN13120.

“IN DE DAG”

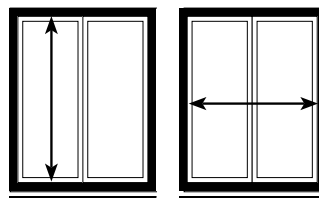

Zowel de breedte als de hoogte dient op diverse plaatsen gemeten te worden. De kleinste maat is bepalend. De gebruikelijke aftrekmaten bij “in de dag” zijn als volgt: 1 cm in de breedte en 1 cm in de hoogte.

“OP DE DAG”

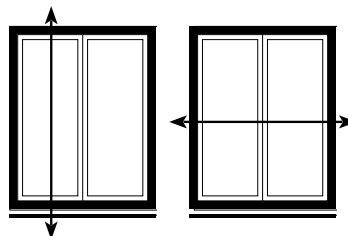

Meet de breedte inclusief de benodigde overlap in breedte en hoogte. De door u opgemeten maten zijn blijvende maten.

DRAAIKIEPRAAM (MET ZIJGELEIDING)

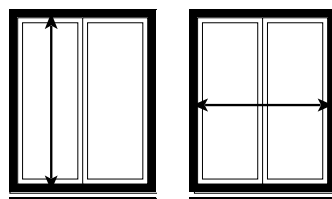

Meet de breedte van het glas inclusief de benodigde overlap. ! Houd rekening met eventuele klinken. Meet de hoogte van de venstervleugel -10 mm. De door u opgemeten maten zijn blijvende maten.

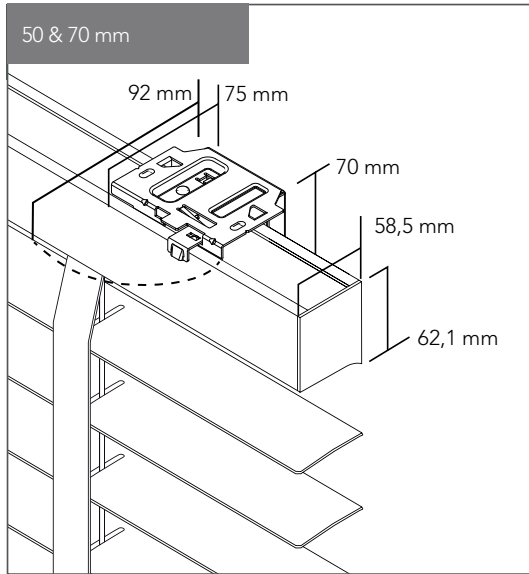
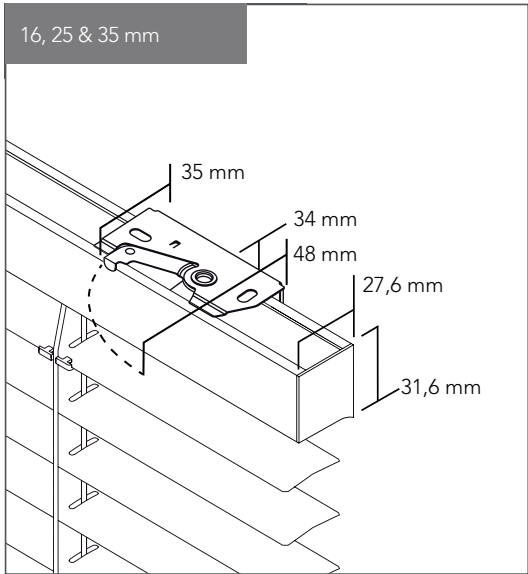

METEN & MONTEREN EASYCLICK®

Afmetingen frame

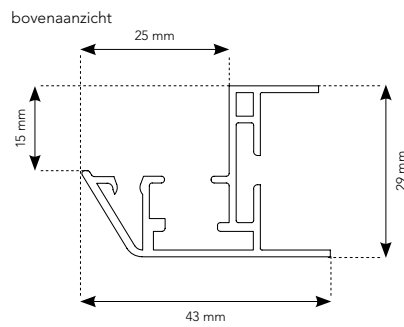

Afstand glas

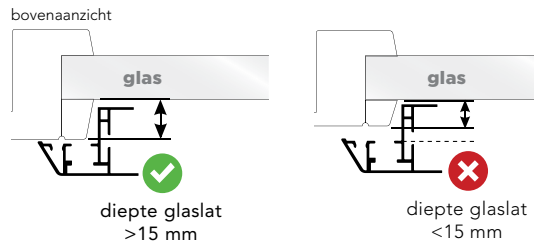

Afstand klink

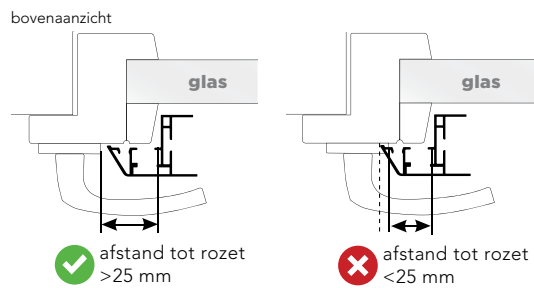

Hechting ondergrond

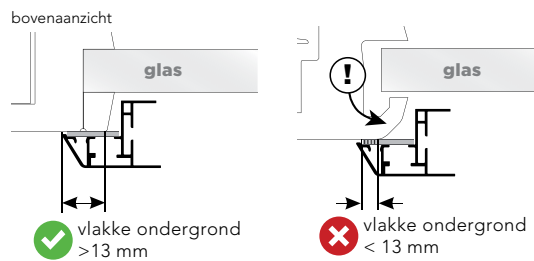

MET MEETHULP

Meethulpstuk EasyClick® Toppoint te bestellen via toppointdealer.eu

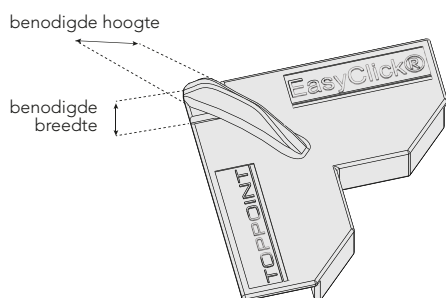

Plaats de meethulp op het kozijn en meet de buitenmaat in de breedte en hoogte.

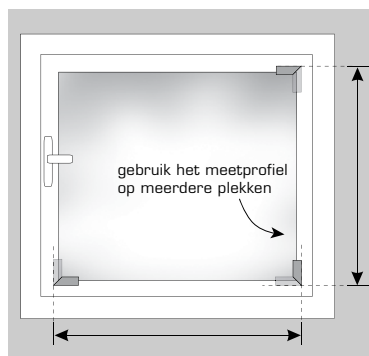

Meten kunststof ramen met meethulp

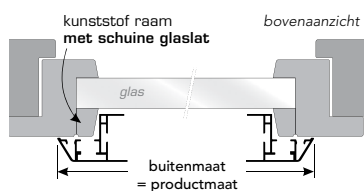

Meten hout en aluminium ramen met meethulp

Meet de buitenmaat min een speling van 3 mm in de breedte en hoogte.

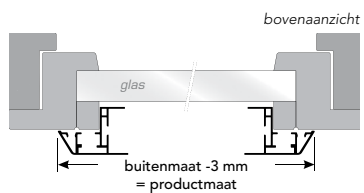

ZONDER MEETHULP

Meten hout en aluminium ramen zonder meethulp

Meet de dagmaat tussen de glaslaten en tel hier 48 mm bij op in de breedte en in de hoogte.

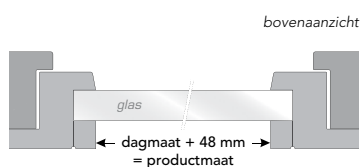

MONTEREN

Ontvet het kozijn van het raam goed met bijgevoegd doekje.

Verwijder aan de achterkant de beschermfolie van de tape en druk vervolgens het hele systeem direct tegen het raam.

Laat de EasyClick® een halve dag in het kozijn om een goede hechting te bevorderen.

METEN EASYEDGE®

Afmetingen frame

bovenaanzicht

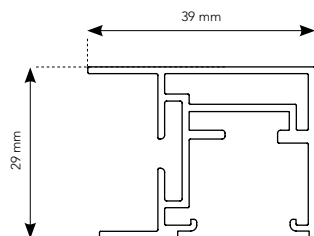

METEN EASYEDGE®

Zowel de breedte als de hoogte dient op minstens 3 plaatsen gemeten te worden.

Bij IDD is de kleinst gemeten maat bepalend,

bij ODD is de grootst gemeten maat bepalend.

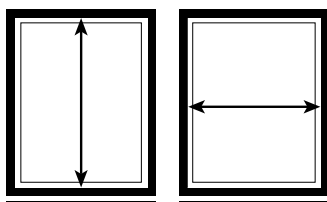

Bestelmaat IDD

Breedte = dagopening -5 mm

Hoogte = dagopening -5 mm

Bestelmaat ODD

Breedte = dagopening +85 mm

Hoogte = dagopening +85 mm

