



ISO PLISSÉ®

www.toppoint.eu

BEDIENINGSMOGELIJKHEDEN

ISO PLISSÉ®

KOORD

Modellen AO

Vrijhangend model met optrekkoord voor verticaal geplaatste ramen. Door een koordkikker op de muur wordt je product kindveilig (ChildSafe).

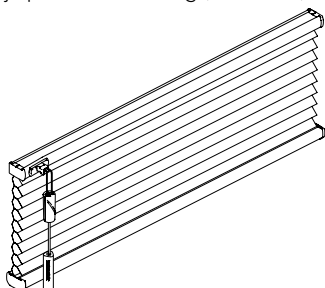

KETTING

Modellen AK

Vrijhangend model met kettinglus voor verticaal geplaatste ramen. De kettingbediening heeft een overbrenging van 1:1 en bij grotere oppervlaktes een overbrenging van 1:3.

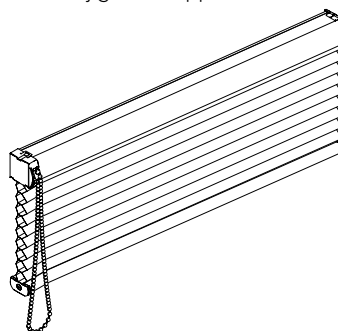

SMARTCORD®

Modellen AU

Vrijhangend model met intrekbaar koordmechanisme voor verticaal geplaatste ramen. Geen loshangende koorden door de constante koordlengte. SmartCord® is 100% ChildSafe.

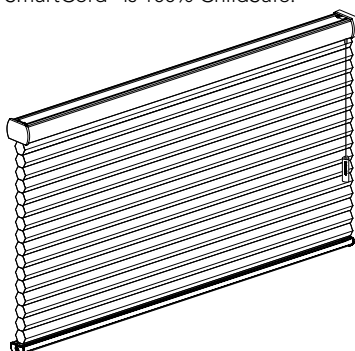

EINDLOOS KOORD

Modellen AL

Vrijhangend model met koordlus voor verticaal geplaatste ramen.

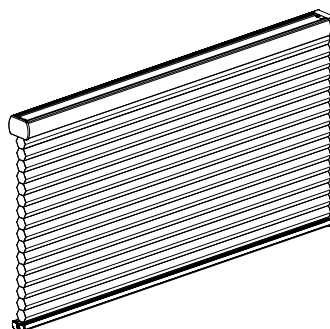

HANDGREEP

Modellen BB & D

Ingespannen model met handgreep, geschikt voor zowel verticaal geplaatste ramen als deuren. Ideaal voor draai-/kiepramen met een maximale helling van 15° (model BB) en dak-/tuimelramen tot 60° (model D). Bij een breedte vanaf 128 cm worden twee handgrepen gemonteerd. De bediening met handgreep is 100% ChildSafe.

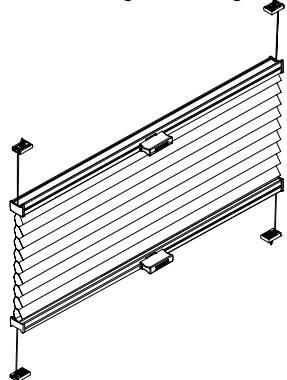

LITERISE®

Modellen AB

Vrijhangend model met handgreep maar zonder ingespannen koorden voor verticaal geplaatste ramen. LiteRise® wordt vanaf 180 cm breed van twee handgrepen voorzien en is 100% ChildSafe.

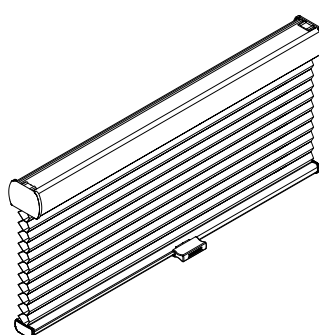

Scan voor
meer
informatie

ROTATIEBEDIENING

Modellen PR

Ingespannen model met slingerstang voor hellende (45°) tot horizontale (90°) ramen zoals lichtkoepels, lichtstraten en serre-daken. De slingerstang is uitneembaar en op verschillende lengtes verkrijgbaar.

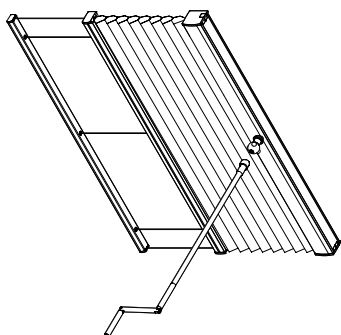

TRUFIT®

Model BB 24 TruFit®

Montage op het raam met tape zonder schroeven of boren. Voor verticaal geplaatste ramen en draai-/kiepramen met een maximale helling van 15°. TruFit® is 100% ChildSafe.

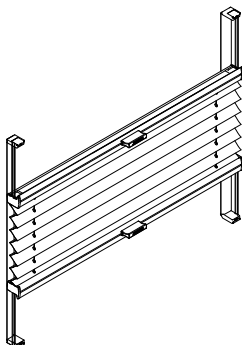

EASYEDGE®

Montage "op de dag" met montageclips of "in de dag" d.m.v. boren. Voor verticaal geplaatste ramen en draai-/kiepramen met een maximale helling van 15° of dakramen met een maximale helling van 60°. Het product is mogelijk met horizontale of verticale bediening. Bij een breedte vanaf 50 cm worden twee handgrepen gemonteerd. EasyEdge® is 100% ChildSafe.

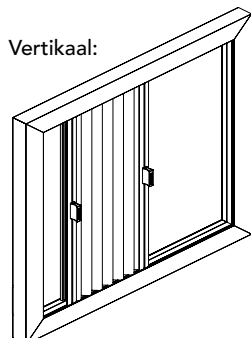
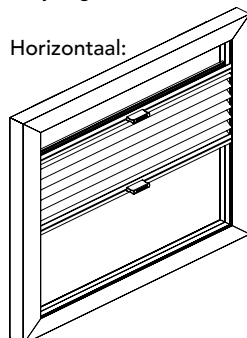

BEDIENINGSSTOK

Modellen PB

Ingespannen model met bedieningsstok voor hellende (45°) tot horizontale (90°) ramen zoals lichtkoepels en hooggeplaatste dakramen. De Iso Plissé® wordt uitgevoerd met een transparante handgreep en de bedieningsstok is op verschillende lengtes verkrijgbaar.

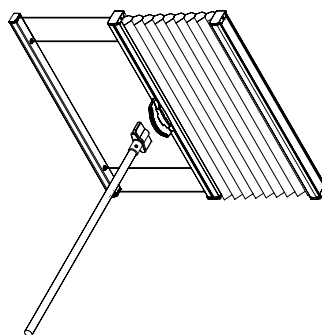

EASYCLICK®

Montage op het kozijn met magneetband zonder schroeven of boren. Voor verticaal geplaatste ramen en draai-/kiepramen met een maximale helling van 15°. Bij een breedte vanaf 50 cm worden twee handgrepen gemonteerd. EasyClick® is 100% ChildSafe.

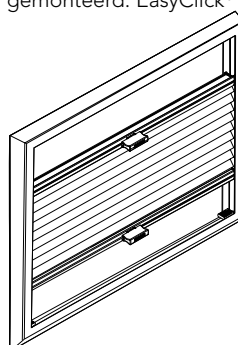

PRODUCT INFORMATIE

ISO PLISSÉ[®], EASYCLICK[®] & EASYEDGE[®]

PROFIELKLEUREN ISO PLISSÉ[®]

Ral 9005 zwart fijnstructuur
antraciet
geanodiseerd
Ral 9001 naturel fijnstructuur
Ral 9016 wit mat
Ral 9016 wit fijnstructuur
Optioneel RAL kleur naar keuze.

PROFIELKLEUREN EASYCLICK[®] & EASYEDGE[®]

zwart mat & fijnstructuur	≈ Ral 9005
antraciet mat & fijnstructuur	≈ Ral 7016
naturel mat & fijnstructuur	≈ Ral 9001
gebroken wit mat & fijnstructuur	≈ Ral 9010
wit mat & fijnstructuur	≈ Ral 9016

Optioneel RAL kleur naar keuze.



MODEL A



profielafmeting

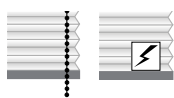
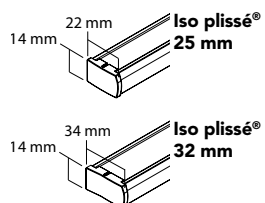

profielafmeting

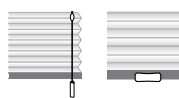
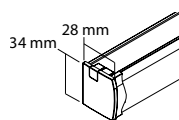

profielafmeting

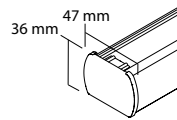

vrijhangende modellen
0-15° graden



AO 10
optrekkkoord



AO 20
optrekkkoord



AO 30*
optrekkkoord



AO 40
optrekkkoord



AO 70
optrekkkoord

vrijhangende modellen
0-15° graden



AK 10
eindloos
ketting



AE 10
elektra



AE 20
elektra

vrijhangende modellen
0-15° graden



AU 10
SmartCord®



AU 20
SmartCord®



AU 30*
SmartCord®



AL 10
eindloos
koord



AL 20
eindloos
koord



AL 30*
eindloos
koord



AB 10
LiteRise®
handgreep



AB 20
LiteRise®
handgreep

Verdeling koorden Iso Plissé®

Productbreedte (cm)	Aantal koorden
0 t/m 180	2
180 t/m 260	3
260 t/m 340	4
340 t/m 360	5

* Bij de modellen met 2 stofpakketten geldt de stofgroep met de kleinste oppervlakte als maximale systeemoppervlakte.

MODEL B



profielafmeting

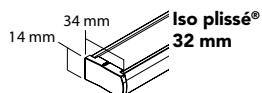
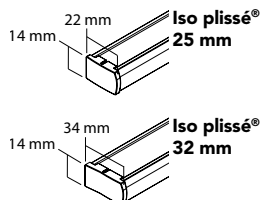

ingespannen modellen
0-15° graden



BO 10
optrekkkoord



BO 16
optrekkkoord



BO 20/20T
optrekkkoord



BO 30/30T*
optrekkkoord



BO 60
optrekkkoord



BO 61
optrekkkoord



BO 75
optrekkkoord



profielafmeting

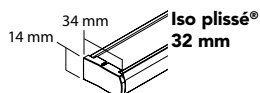
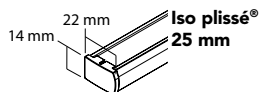

ingespannen modellen
0-15° graden



BB 10/10T
handgreep



BB 15/15T
handgreep



BB 20/20T
handgreep



BB 24
handgreep



BB 30/30T*
handgreep



BB 35/35T*
handgreep

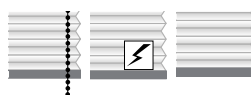

profielafmeting

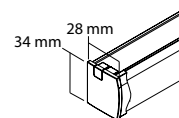

ingespannen modellen
0-15° graden



BK 10
eindloos
ketting



BK 16
eindloos
ketting



BE 10
elektra



BE 16
elektra



BF 50/55
vast



BF 51/56
vast

MODEL D



profielafmeting

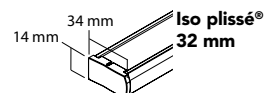
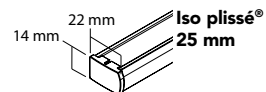

dakraam modellen
max. 60° graden



DB 10/10T
handgreep



DB 15
handgreep



DB 20/20T
handgreep



DB 30/35*
handgreep

* Bij de modellen met 2 stofpakketten geldt de stofgroep met de kleinste oppervlakte als maximale systeemoppervlakte.

Bij de DB modellen is de bedieningsstok optioneel.
Model DB is uitermate geschikt voor dakramen van het merk Fakro en Velux.
Teven bestelbaar met het dakraam typenummer.

MODEL P



profielafmeting

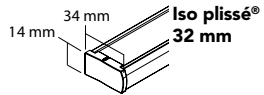
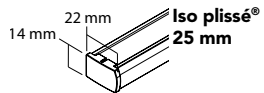

profielafmeting

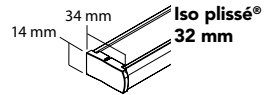
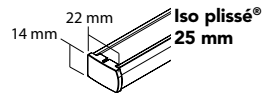

profielafmeting

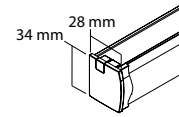

profielafmeting

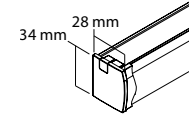

plafond modellen
max. 90° graden



PB 10/15
handgreep



PB 30/35*
handgreep



PB 40
handgreep



PB 41
handgreep



PB 45
handgreep



PB 46
handgreep

plafond modellen
max. 90° graden



PB 60
handgreep



PB 61
handgreep



PB 65
handgreep



PB 66
handgreep



PB 70
handgreep



PB 71
handgreep



PB 75
handgreep



PB 76
handgreep



PB 80
handgreep



PB 81
handgreep



PB 85
rotatie



PB 86
rotatie

plafond modellen
max. 90° graden



PR 10
rotatie



PR 15
rotatie



PR 16
rotatie



PR 60
rotatie



PR 61
rotatie



PR 65
rotatie



PR 66
rotatie



PR 70
rotatie



PR 71
rotatie



PR 75
rotatie



PR 76
rotatie

plafond modellen
max. 90° graden



PE 10
elektra



PE 15
elektra



PE 16
elektra



PE 60
elektra



PE 61
elektra



PE 65
elektra



PE 66
elektra



PE 70
elektra



PE 71
elektra



PE 75
elektra



PE 76
elektra

* Bij de modellen met 2 stofpakketten geldt de stofgroep met de kleinste oppervlakte als maximale systeemoppervlakte.

TECHNISCHE INFORMATIE

ISO PLISSÉ®

	Technische Informatie								
	Min. breedte (cm)	Max. breedte (cm)	Min. hoogte (cm)	Max. hoogte (cm)**	Max. verschil breedte onder/boven	Min. hoek (°)	Max. hoek (°)	Max. opp. (m ²) per stofgroep	zijgeleiding mogelijk
	S2/S3								
AO 10	40	300	10	300	-	-	-	6/6	ja
AO 20	40	300	10	300	-	-	-	6/6	ja
AO 30*	40	300	10	300	-	-	-	5/4	ja
AO 40	40	210	30	300	-	1	50	4/3	nee
AO 70	40	210	10	180	-	1	60	-	nee
AK 10	45*5	360	50	300	-	-	-	7/6	nee
AE 10	65	300	10	300	-	-	-	10/8	ja
AE 20	90***	300	15	300	-	-	-	6/6	ja
AU 10 SmartCord®	43*1	360	15	300	-	-	-	-	nee
AU 20 SmartCord®	55*2	360	15	300	-	-	-	-	nee
AU 30* SmartCord®	55*2	360	30	300	-	-	-	6/6	nee
AL 10	35*3	360	70	300	-	-	-	-	nee
AL 20	45*4	360	70	300	-	-	-	-	nee
AL 30*	45*4	360	70	300	-	-	-	7/6	nee
AB 10 LiteRise®	45	240	15	210	-	-	-	-	nee
AB 20 LiteRise®	57	240	15	210	-	-	-	5/5	nee
BO 10	40	240	10	300	-	-	-	5/5	ja
BO 16	40	240	20	300	-	-	-	5/5	ja
BO 20/20T	40	240	20	300	-	-	-	5/5	ja
BO 30/30T*	40	240	30	300	-	-	-	4/3	ja
BO 60	40	230	20	260	50	10	89	5/5	nee
BO 61	40	230	20	260	50	10	89	5/5	nee
BO 75	180	210	20	180	-	1	60	5/5	nee
BB 10/10T	15	150	20	230	-	-	-	-	ja
BB 15/15T	15	150	20	230	-	-	-	-	ja
BB 20/20T	15	150	10	230	-	-	-	-	ja
BB 24	20	128	20	254	-	-	-	-	ja
BB 24XL	128,1	170	20	230	-	-	-	-	ja
BB 24 TruFit®	25	128	20	230	-	-	-	3/2,5	nee
BB 30/30T*	25	150	30	230	-	-	-	3/2,5	ja
BB 35/35T*	25	150	30	230	-	-	-	3/2,5	ja
BK 10	50	360	50	300	-	-	-	6/5	nee
BK 16	50	360	50	300	-	-	-	6/5	nee
BE 10	51	360	25	300	-	-	-	6/6	ja
BE 16	51	360	25	300	-	-	-	6/6	ja
BF 50/55	15	60	20	60	-	-	-	-	nee
BF 51/56	15	120	20	60	-	-	-	-	nee
DB 10/10T	30	150	20	220	-	-	-	2,2/2,2	ja
DB 15	30	150	20	220	-	-	-	2,2/2,2	ja
DB 20/20T	30	150	20	220	-	-	-	2,2/2,2	ja
DB 30/35*	30	150	20	220	-	-	-	2,2/2,2	ja
BB 10 EasyClick®	25	150	20	235	-	-	15	-	nee
BB 24 EasyClick®	32	133	20	260	-	-	15	-	nee
BB 30/35 EasyClick®	32	150	20	235	-	-	15	-	nee

* Bij de modellen met 2 stofpakketten geldt de stofgroep met de kleinste oppervlakte als maximale systeemoppervlakte.

Modellen met insectscreen zijn BB 30/30T, BB 35/35T. Maximale hoogte bij insectscreen is 150 cm.

** Maximale hoogte bij Batiste 32 mm & Batiste sheer 25 mm is 260 cm.

Maximale hoogte bij Batiste 25 mm is 230 cm.

*** Minimale breedte 100 cm bij hoogte > 270 cm.

*1 Minimale breedte 46 cm bij hoogte > 270 cm.

*2 Minimale breedte 59 cm bij hoogte > 270 cm.

*3 Minimale breedte 45 cm bij hoogte > 270 cm.

*4 Minimale breedte 55 cm bij hoogte > 270 cm.

*5 Minimale breedte 50 cm bij hoogte > 270 cm.

Bij een breedte > 128 cm wordt een BB-model & DB-model met 2 handgrepen per profiel geleverd.

TECHNISCHE INFORMATIE

ISO PLISSÉ®

Technische Informatie										
	Min. breedte boven (cm)	Min. breedte onder (cm)	Max. breedte (cm)	Min. hoogte (cm)	Max. hoogte (cm) per stofgroep**	Max. verschil breedte onder/boven	Min. hoek (°)	Max. hoek (°)	Max. opp. (m ²) per stofgroep	zijgeleiding mogelijk
	S2/S3					S2/S3				
PB 10/15	20	-	150	10	400/350	-	-	-	6/5	ja
PB 30/35*	20	-	150	10	400/350	-	-	-	5/4	ja
PB 40	-	20	100	30	260/260	100	-	-	-	nee
PB 41	-	20	150	30	260/260	75	-	-	-	nee
PB 45	20	0	100	30	260/260	100	-	-	-	nee
PB 46	20	0	150	30	260/260	75	-	-	-	nee
PB 60	12	20	150	10	260/260	88	10	89	-	nee
PB 61	12	20	150	10	260/260	69	10	89	-	nee
PB 65	20	12	150	10	260/260	88	10	89	-	nee
PB 66	20	12	150	10	260/260	69	10	89	-	nee
PB 70	0	20	100	10	260/260	100	10	89	-	nee
PB 71	0	20	150	10	260/260	75	10	89	-	nee
PB 75	20	0	100	10	260/260	100	10	89	-	nee
PB 76	20	0	150	10	260/260	75	10	89	-	nee
PB 80	12	40	100	30	260/260	88	15	-	-	nee
PB 81	12	40	100	30	260/260	69	15	-	-	nee
PB 85	40	12	100	30	260/260	88	15	-	-	nee
PB 86	40	12	100	30	260/260	69	15	-	-	nee
PR 10	20	-	230	10	400/350	-	-	-	6/5	nee
PR 15	20	-	230	10	400/350	-	-	-	5/4	nee
PR 16	20	-	230	10	400/350	-	-	-	5/4	nee
PR 60	12	20	230	10	260/260	88	10	89	5/5	nee
PR 61	12	20	230	10	260/260	88	10	89	5/5	nee
PR 65	20	12	230	10	260/260	88	10	89	5/5	nee
PR 66	20	12	230	10	260/260	88	10	89	5/5	nee
PR 70	0	20	100	10	260/260	100	10	89	-	nee
PR 71	0	20	150	10	260/260	75	10	89	-	nee
PR 75	20	0	100	10	260/260	100	10	89	-	nee
PR 76	20	0	150	10	260/260	75	10	89	-	nee
PE 10	85	-	230	20	400/350	-	-	-	5/4	ja
PE 15	85	-	230	20	400/350	-	-	-	5/4	ja
PE 16	85	-	230	20	400/350	-	-	-	5/4	ja
PE 60	12	35	230	25	260/260	88	10	89	5/4	nee
PE 61	12	35	230	25	260/260	69	10	89	5/4	nee
PE 65	35	12	230	25	260/260	88	10	89	5/4	nee
PE 66	35	12	230	25	260/260	69	10	89	5/4	nee
PE 70	0	35	100	25	260/260	100	10	89	-	nee
PE 71	0	35	150	25	260/260	75	10	89	-	nee
PE 75	35	0	100	25	260/260	100	10	89	-	nee
PE 76	35	0	150	25	260/260	75	10	89	-	nee

* Bij de modellen met 2 stofpakketten geldt de stofgroep met de kleinste oppervlakte als maximale systeemoppervlakte. Modellen met insectscreen zijn BB 30/30T, BB 35/35T. Maximale hoogte bij insectscreen is 150 cm.

** Maximale hoogte bij Batiste 32 mm & Batiste sheer 25 mm is 260 cm. Maximale hoogte bij Batiste 25 mm is 230 cm.

ZIJGELEIDINGSPROFIELEN ISO PLISSÉ®

L-zijgeleidingsprofiel voor dakramen

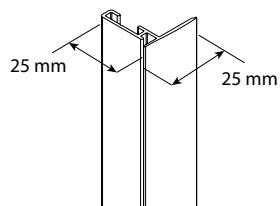

Type S1: montage met schroef
Montage: in de dag
Hoek kozijnstijl: 90 en 96° graden
Modellen: AO, AE, BB, BO, BE, DB,
PB & PE

U-zijgeleidingsprofiel voor rechte ramen

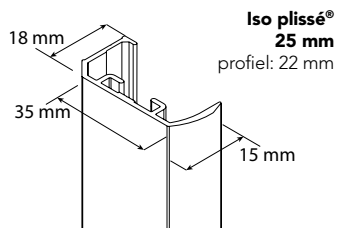

Type A1: montage met tape
Montage: in de dag & op de dag
Modellen: AO, AE, BB, BO, BE
Max. productbreedte: 180 cm (AE)
Max. productbreedte: 128 cm (overig)

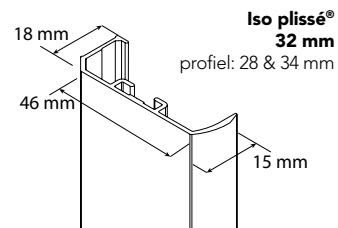

Type A1: montage met tape
Montage: in de dag & op de dag
Modellen: AO, AE, BB, BO, BE
Max. productbreedte: 180 cm (AE)
Max. productbreedte: 128 cm (overig)

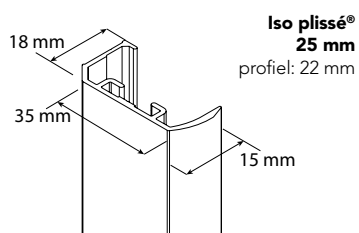

Type S3: montage met schroef
Montage: in de dag & op de dag
Modellen: AO, AE, BB, BO, BE

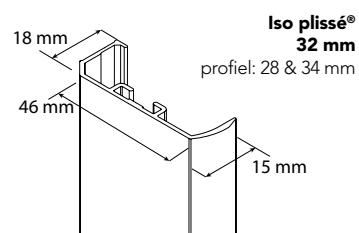

Type S3: montage met schroef
Montage: in de dag & op de dag
Modellen: AO, AE, BB, BO, BE



TRUFIT® & EASYCLICK®

TruFit®
Iso plissé® 25 mm & plissé 20 mm

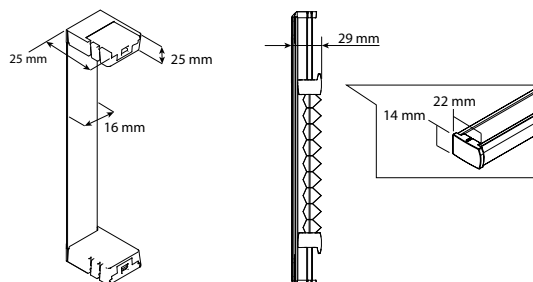

montage: op het raam
0-15° graden



BB 24 TruFit®
plooi 25 mm
handgrip

EasyClick®
Iso plissé® 25 mm & plissé 20 mm

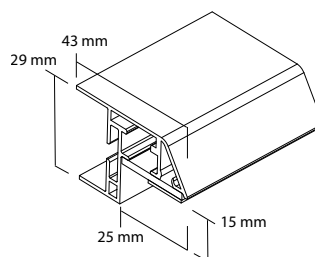

montage: op het kozijn
0-15° graden



BB 10
handgrip



BB 24
handgrip



BB 30/35
handgrip

Modellen met insectscreen zijn BB 30 & BB 35.
Maximale hoogte bij insectscreen is 155 cm.
Het is mogelijk om een frame te kiezen met een kleur die afwijkt van het greepprofiel.

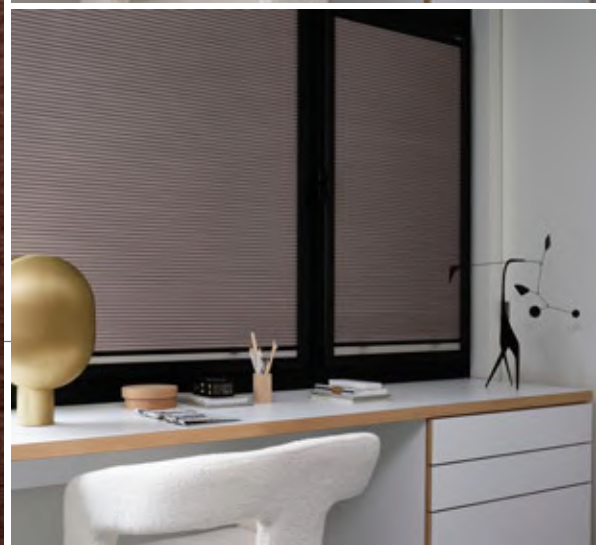

EASYEDGE®

EasyEdge®
Iso plissé® 25 mm & plissé 20 mm

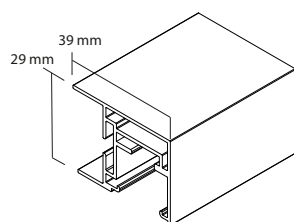

montage: op de dag & in de dag
0-15° graden

horizontaal

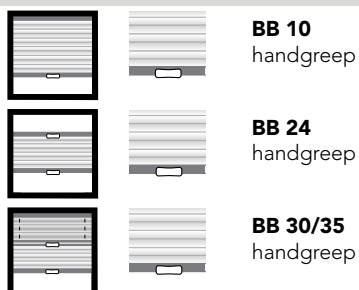

vertikaal

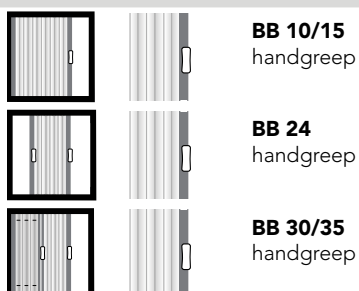

EasyEdge®
Iso plissé® 25 mm & plissé 20 mm

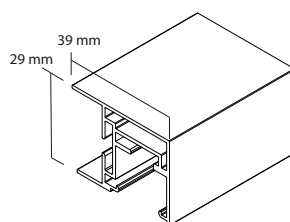

montage: op de dag & in de dag
0-60° graden

horizontaal

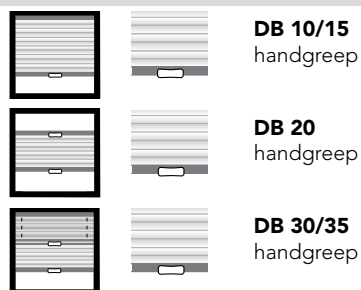

vertikaal

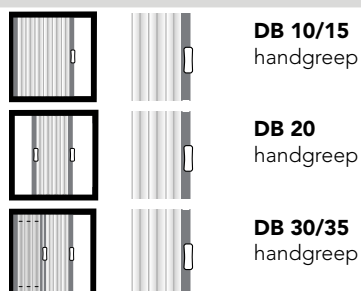

Modellen met insectscreen zijn BB 30 & BB 35.
Maximale hoogte bij insectscreen is 155 cm.
Het is mogelijk om een frame te kiezen met een kleur die afwijkt van het greepprofiel.

Vanaf 50 cm breed heeft de EasyClick® & EasyEdge® 2 handgrepen per profiel.

Bij EasyEdge® IDD is de optie om een alu afdekstrip te bestellen in bijpassende kleur en afwerking van het frame.

ELEKTRA



MOTOREN BREL

Voeding (verplicht te kiezen)	12 volt
Brel T1 transformator (max. 1 product)	✓
Brel T3 transformator (max. 3 producten)	✓
Opladbare accu extern USB-C	✓
Eigenschappen	12 volt
Interne accu	
Externe accu	✓
Bedrade stroomvoorziening 230 volt	
Bedrade stroomvoorziening transformator	✓
Type oplaadpunt	USB-C
Motor specificaties	12 volt AE 20
Kabel lengte (mm)	300
Besturingen: 1-weg communicatie Geeft geen terugkoppeling	✓
Besturingen: 2-weg communicatie Geeft terugkoppeling Bi-directioneel	✓
Domotica	12 volt
Draadloze domotica (HUB)	✓
Bedrade domotica huisautomatisering	
Toebehoren	12 volt
Brel T3 splitter (2-weg)	✓
Brel T3 verlengkabel (25/50/100/200/500 cm)	✓
Brel USB-C oplader (3 meter kabel)	✓
Brel 15 kanaals afstandsbediening	✓
Brel 1 kanaals wandschakelaar	✓
Brel Hub DD-1554	✓
Brel Hub DD-7002B	✓

MOTOREN SOMFY

Voeding (verplicht te kiezen)	12 volt Tilt & Lift	24 volt mech.
Somfy 12 volt transformator	✓	
Somfy transformator 1.5		✓
Somfy transformator 2.7		✓
Opladbare accu extern USB-C	✓	
Eigenschappen	12 volt Tilt & Lift	24 volt mech.
Interne accu		
Externe accu	✓	
Bedrade stroomvoorziening 230 volt		
Bedrade stroomvoorziening transformator	✓	✓
Type oplaadpunt	JST	n.v.t.
Motor specificaties	12 volt Tilt & Lift	24 volt mech.
Kabel lengte (mm)	100	300
Besturingen: 1-weg communicatie Geeft geen terugkoppeling RTS	✓	✓
Besturingen: 2-weg communicatie Geeft terugkoppeling IO		
Domotica	12 volt Tilt & Lift	24 volt mech.
Draadloze domotica (HUB)	✓	
Bedrade domotica huisautomatisering		✓
Toebehoren	12 volt Tilt & Lift	24 volt mech.
Somfy 12 volt oplader (3 meter kabel)	✓	
Somfy ontvanger RTS 25		✓
Situo 1 RTS - 1 kanaals afstandsbediening	✓	✓
Situo 5 RTS - 5 kanaals afstandsbediening	✓	✓
Smooove Origin RTS - 1 kanaals wandschakelaar	✓	✓

KOPPELEN MET BREL MOTOREN

Koppelen met hub

Alle motoren van Brel zijn met onder andere de volgende draadloze domotica systemen te gebruiken:

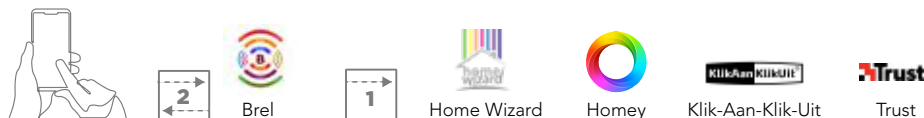

Koppelen met spraakbesturing



